

# User Manual

## Amplifiers

**SA20:2 - SA30:2 - SA100:2**







***APG***

---



## Contents

<b>1</b>	<b>Warnings</b>	<b>5</b>
1.1	Important Safety Instructions . . . . .	5
1.2	Approvals . . . . .	6
1.3	Warning Notices  . . . . .	7
1.3.1	Location . . . . .	7
1.3.2	Precautions Regarding Installation . . . . .	7
1.4	Safety Rules  . . . . .	7
1.5	Speaker Damage  . . . . .	8
1.6	Speaker Output Shock Hazard  . . . . .	8
<b>2</b>	<b>Front and Rear Panel Reference Figures</b>	<b>9</b>
<b>3</b>	<b>Welcome</b>	<b>10</b>
3.1	Introduction . . . . .	10
3.2	The SA Amplifiers . . . . .	10
3.3	More sound, less weight . . . . .	10
3.4	The Show Always Goes On . . . . .	10
<b>4</b>	<b>Installation</b>	<b>11</b>
4.1	Unpacking . . . . .	11
4.2	Mounting . . . . .	11
4.3	Cooling . . . . .	11
4.4	Operating Precautions . . . . .	12
4.5	Grounding . . . . .	12
4.6	AC Mains connection . . . . .	12
<b>5</b>	<b>Connections and Operation</b>	<b>14</b>
5.1	Connecting Audio Inputs . . . . .	14
5.2	Connecting Audio Outputs . . . . .	15
5.3	Internal Signal Path Polarity . . . . .	16
5.4	Remote Control Connection . . . . .	17
5.4.1	V Ext . . . . .	17
5.4.2	Serial Connection . . . . .	18
5.5	Amplifier configuration and setting . . . . .	18
5.5.1	Introduction . . . . .	18
5.5.2	The main screen and the LED bars . . . . .	18
5.6	Front Panel Buttons . . . . .	19
<b>6</b>	<b>The main menu</b>	<b>20</b>
<b>7</b>	<b>Amplifier Settings</b>	<b>22</b>
7.1	Output attenuation . . . . .	22
7.2	Input Gain/Sensitivity . . . . .	22
7.3	Input select . . . . .	23

7.4	Max output voltage	23
7.5	Max mains current	23
7.6	Clip Limiter CH1 - CH2	24
7.7	Gate CH1 - CH2	24
7.8	Mute At Power On	25
7.9	Idle Mode	25
<b>8</b>	<b>Display</b>	<b>27</b>
8.1	Output Meters	27
8.2	Temperature	27
8.3	Mains meters	27
8.4	Amplifier Name	28
<b>9</b>	<b>Local presets</b>	<b>29</b>
9.1	Locked presets	29
9.2	Locked bank size	29
9.3	Recall local preset	29
9.4	Save local preset	30
9.5	Overwriting an existing preset	31
9.6	Change Lock Code	32
9.7	Erase all presets	32
<b>10</b>	<b>Setup</b>	<b>34</b>
10.1	Hardware info	34
10.2	Hardware monitor	34
10.3	LCD contrast	34
10.4	Key Locking and Setting	35
10.5	Single Channel Muting	35
<b>11</b>	<b>Protection</b>	<b>36</b>
11.1	Turn-On/Turn-Off muting	36
11.2	Short circuit protection	36
11.3	Thermal protection	36
11.4	DC fault protection	36
11.5	Input/Output protection	37
<b>12</b>	<b>User Maintenance</b>	<b>38</b>
12.1	Cleaning	38
12.2	Service	38
12.3	Dust Removal	38
<b>13</b>	<b>Warranty Product</b>	<b>39</b>
<b>14</b>	<b>Assistance</b>	<b>39</b>
14.1	Amplifier Error Codes	40
14.2	SmartCard function	40
<b>15</b>	<b>Technical specifications</b>	<b>42</b>

## 1 Warnings

### 1.1 Important Safety Instructions

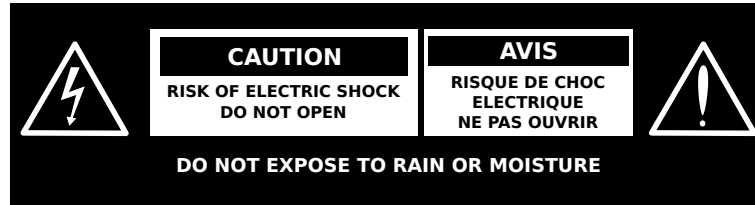

**Caution:** Risk of electric shock do not open !

**Caution:** In order to reduce the risk of electric shock, do not attempt to open any part of the unit. no user-serviceable parts inside. refer servicing to qualified service personnel.

**Warning:** To reduce the risk of fire or electric shock, do not expose this apparatus to rain or moisture. objects filled with liquids, such as vases, should not be placed on this apparatus to completely disconnect this apparatus from the ac mains, disconnect the power supply cord plug from the AC receptacle

The mains plug of the power supply cord must remain readily accessible

### Safeguards

Electrical energy can perform many useful functions. This unit has been engineered and manufactured to assure your personal safety. Improper use can result in potential electrical shock or fire hazards. In order not to defeat the safeguards, observe the following instructions for its installation, use and servicing.

- Read these instructions.
- Keep these instructions.
- Heed all warnings.
- Follow all instructions.
- Do not use this amplifier near water.
- Clean only with a dry cloth.
- Do not block any ventilation openings.
- Install in accordance with the manufacturer's instructions.
- Do not install near any heat sources such as radiators, heat registers, stoves, or other apparatus (including amplifiers) that produce heat.
- Do not defeat the safety purpose of the polarized or grounding-type plug. A polarized plug has two blades with one wider than the other. A grounding type plug has two blades and a third grounding prong. The wide blade or the third prong are provided for

your safety. If the provided plug does not fit into your outlet, consult an electrician for replacement of the obsolete outlet.

- Protect the power cord from being walked on or pinched particularly at plugs, convenience receptacles, and the point where they exit from the apparatus.
- Only use attachments/accessories specified by the manufacturer.
- Unplug this amplifier during lightning storms or when unused for long periods of time.

Refer all servicing to qualified service personnel. Servicing is required when the amplifier has been damaged in any way. For example if the power-supply cord or plug have been damaged, if liquid has been spilled or objects have fallen into the amplifier, if the amplifier has been exposed to rain or moisture, if it has been dropped or if it does not operate normally.

**Caution** To prevent fire hazard, Class 2 wiring cable should be used for connection with speakers. Cabling should be routed away from potential hazards to avoid damage to the insulation of the cable itself.

### Explanations of graphical symbols:



The Lightning Flash with arrowhead symbol within an equilateral triangle is intended to alert the user to the presence of uninsulated dangerous voltage within the product enclosure that may be of sufficient magnitude to constitute a risk of shock to persons.



The exclamation point within an equilateral triangle is intended to alert the user to the presence of important operating and maintenance (servicing) instructions in the literature accompanying the product.

## 1.2 Approvals

The SA amplifiers are installed according to the Canadian Electrical Code or National Electrical Code, as applicable. Install this product in accordance with Canadian Electrical Code or National Electrical Code and other local electrical or building codes as applicable. Mount in rack only. The flexible mains cable must not pass through walls.

This equipment has been tested and found to compliant by Notified Body 2047 (Directive 2004/108/EC-EMC) pursuant to the product family standard for audio professional use: EN 551031 and EN 55103-2 standard; EN61000-3-2, EN 61000-3-3. Electromagnetic Ambients E4, E5.

This equipment has been tested and found to compliant by Notified Body 2047 (Directive 2004/108/EC-EMC) pursuant to the product family standard for audio professional use: Radiated emissions FCC standard section 15.109, IEC CISPR standard Pub. 22 ed 6.0 (2008-09) CLASS A chapter :7.1.1, Conducted emission FCC standard section 15.107, IEC CISPR standard Pub. 22 ed 6.0 (2008-09) CLASS B. This equipment has been tested and found to comply by Notified Body 2047(Directive 2006/95/EC L.V.) pursuant to the audio apparatus safety requirements: Standard EN 60065

In a domestic environment this product may cause radio interferences in which case the user may be required to take adequate measures.

- Average half-cycle RMS inrush current on initial switch-on for SA20:2 and SA30:2: 10 A
- Average half-cycle RMS inrush current after a supply interruption of 5s for SA20:2 and SA30:2: 10 A

### 1.3 Warning Notices

#### 1.3.1 Location

Install the amplifier in a well-ventilated location where it will not be exposed to high temperature or humidity. Do not install the amplifier in a location that is exposed to direct sun rays, or near hot appliances or radiators. Excessive heat can adversely affect the cabinet and internal components. Installation of the amplifier in a damp or dusty environment may result in malfunction or accident.

#### 1.3.2 Precautions Regarding Installation

Placing and using the amplifier for long periods of time on heat generating sources will affect its performance. Avoid placing the amplifier on heat generating sources. Install this amplifier as far as possible from tuners and TV sets. An amplifier installed in close proximity of such equipment may experience noise or generic performance degradation.

**warning.pdf** To prevent fire or electric shock:

- The ventilation openings must not be impeded by any item such as newspapers, tablecloths, curtains etc; keep a distance of at least 50 cm from the front and rear ventilation openings of the amplifier.
- Do not expose this amplifier to rain or moisture. This equipment must not be exposed to dripping or splashing liquids: objects filled with liquids, such as vases, must not be placed on the amplifier.

### 1.4 Safety Rules

- This device must be powered exclusively by earth connected mains sockets in electrical networks compliant to the IEC 364 or similar rules.
- It is absolutely necessary to verify this fundamental requirement of safety and, in case of doubt, require an accurate check by qualified personnel.
- The manufacturer cannot be held responsible for damages caused to persons, things or data due to an improper or missing ground connection.
- Before powering this amplifier, verify that the correct voltage rating is being used.
- Verify that your mains connection is capable of satisfying the power ratings of the device.
- Do not spill water or other liquids into or on the amplifier.
- Do not use this amplifier if the electrical power cord is frayed or broken.

- Do not remove the cover (except for the topmost user installable accessory panel). Failing to do so will expose you to potentially dangerous voltage.
- No naked flame sources such as lighted candles should be placed on the amplifier.
- Provide a sectioning breaker between the mains connections and the amplifier. Suggested device is 16A/250VAC, C or D curve, 10KA (SA20:2-SA30:2)
- Contact the authorized service center for ordinary and extraordinary maintenance.
- The power cord type is LAPP CABLE OLFLEX191 3G6 / SJT 3XAWG10 SALCAVI (Bahoing SJT 3x16AWG or I-sheng SGIS 3G1,5mmq for SA30:2 - SA20:2)

### **1.5 Speaker Damage**

APG Class D amplifiers are capable of producing much more power than many loudspeakers can handle. It is the user's responsibility to use speakers suitable to the amplifier and to use them in a sensible way that will not cause damage. APG will not be held responsible for damaged speakers. Consult APG for power handling recommendations. Even if you reduce the gain using the amplifier's front panel attenuation controls, it is still possible to reach full output power if the input signal level is high enough. A single high-power tone can damage high frequency drivers almost instantaneously, while low frequency drivers can usually withstand very high, continuous power levels for a few seconds before they fail. Reduce power immediately if you hear any speaker bottoming out - harsh pops or cracking distortion that indicate that the speaker voice coil or diaphragm is striking the magnet assembly. APG recommends that you use amplifiers of this power range for more headroom (cleaner sound) rather than for increased volume.

### **1.6 Speaker Output Shock Hazard**

A Class D amplifier is capable of producing hazardous output voltages. To avoid electrical shock, do not touch any exposed speaker wiring while the amplifier is operating. This manual contains important information on operating your APG amplifier correctly and safely. Please read it carefully before operating your amplifier. If you have any questions, please contact APG France.



## 2 Front and Rear Panel Reference Figures

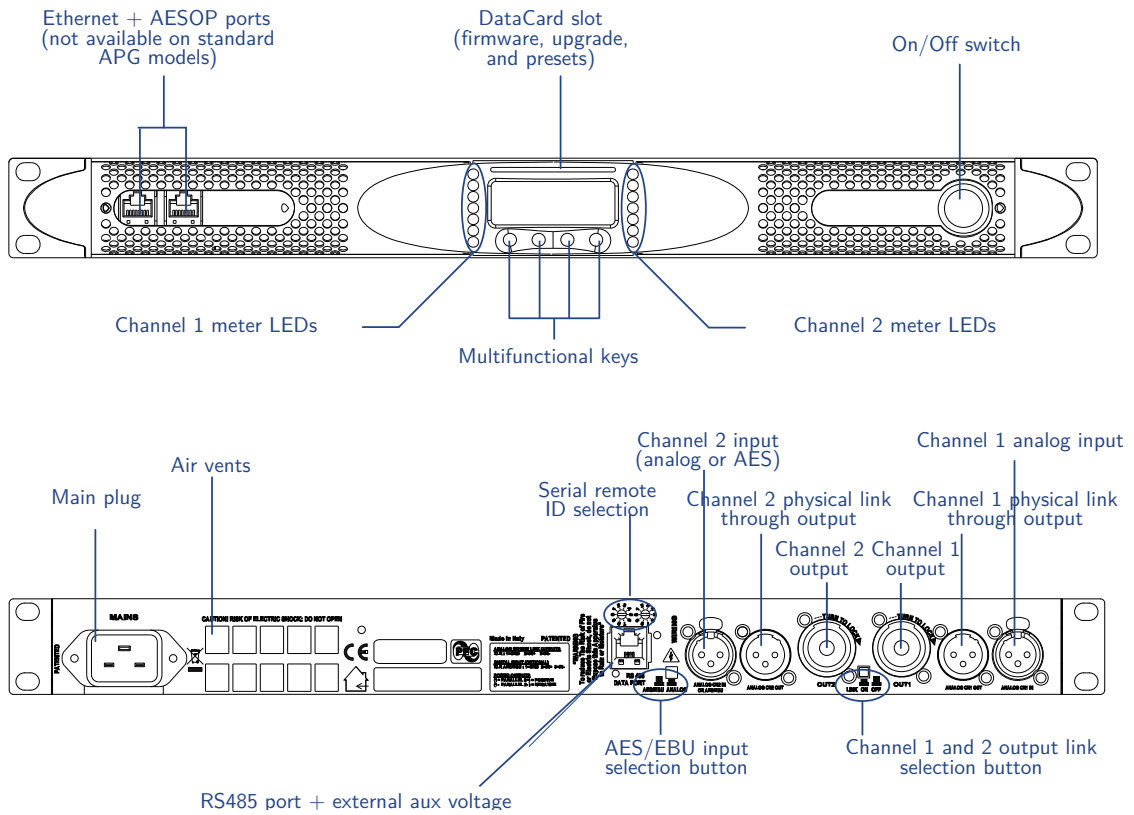

Figure 1: Front and rear panels

## **3 Welcome**

### **3.1 Introduction**

Congratulations on buying a APG SA20:2 or SA30:2 amplifier. Class D technology has changed the way the world looks at professional audio amplification: no other amplifier's performance comes close for applications demanding high power and long term reliability. This allows amazing reductions in heat output and weight, without sacrificing output powers.

### **3.2 The SA Amplifiers**

SA Amplifiers have many advanced features, digital control of many parameters, adjustable maximum mains consumption, selectable digital presets and a graphic display that shows detailed information of the status of the amplifier. All SA amplifiers come with built in Power Factor Correction. This unique feature ensures that a predominantly resistive load is presented to mains this minimizing current distortion and voltage/current displacement. This leads to improved performance of the amplifier at high levels of output and avoids mains-voltage collapses, typical of standard and switching power supplies. Another great advantage of this technology is that its performance is, to a large extent, independent of mains voltage. The rated output power does not vary with load/line conditions.

### **3.3 More sound, less weight**

Class D technology based amplifiers are highly efficient, delivering greater power to speakers with reduced heat dissipation: typical running efficiency of output stages is 95%, with only 5% of input energy dissipated as heat. This allows for smaller dimensions, weight and power consumptions. Contrary to conventional amplifiers which achieve highest efficiency only at full rated power output, Class D efficiency is almost independent of output level. Music has an average power density of 40% of its peak value; this means that other (non-class D) amplifiers can easily generate 10 times more heat than class-D products for the same sound pressure level. SA amplifiers deliver crystal-clear highs, and a tight, welldefined low end : the most accurate reproduction of an audio signal. Solid time proven design features ensure extremely high performance in terms of super low total harmonic distortion, optimal frequency response, high power bandwidth and damping factor across a vast number of application scenarios. Pulse Width Modulation (PWM) high frequency sampling techniques is just one of the many factors contributing to the SA amplifiers high performance ratings across the audio bandwidth.

### **3.4 The Show Always Goes On**

The SA amplifiers offers complete protection against any possible operation error. Every amplifier in this series is designed to work under a large range of possible conditions, delivering maximum power with maximum safety and an outstanding long term reliability. Anticipating potential problems at the design stage means your show always goes on!

## 4 Installation

### 4.1 Unpacking

Carefully open the shipping carton and check for any noticeable damage; figure 2 shows the packing view. Every APG amplifier is completely tested and inspected before leaving the factory and should arrive in pristine condition. In the unlikely event that you should encounter any damage, please notify the shipping company immediately. Be sure to save all packing materials for the carrier's inspection. The SA box contains the following:

- 1 × SA amplifier
- 1 × AC Mains cord
- 1 × User Guide

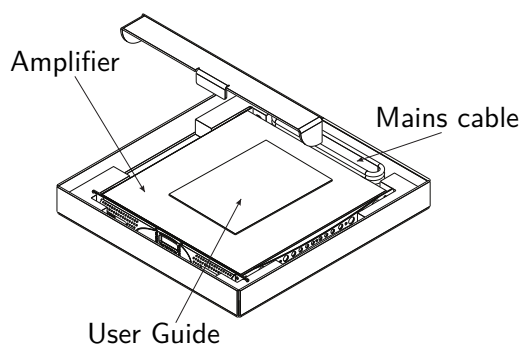

Figure 2: Packaging box

### 4.2 Mounting

All APG amplifiers are designed for standard 19" rack mounting; there are four front panel holes and two rear-lateral holes. In order to limit the risk of mechanical damages, amplifiers must be fixed to the rack using both frontal as well as rear mounting holes.

### 4.3 Cooling

All APG amplifiers implement a forced-air cooling system to maintain low and constant operating temperatures. Drawn by an internal fan, air enters through the slots in the front panel and is forced over all components, exiting at the back of the amplifier. The amplifier's cooling system features an intelligent variable-speed DC fan which is controlled by heat sink temperature sensing circuits: the fan speed will increase only when the temperature recorded by the sensors rises over carefully predetermined values. This ensures that fan noise and internal dust accumulation are kept to a strict minimum. Should however the amplifier be subject to an extreme thermal load, the fan will force a very large volume of air through the heat sink. In the extremely rare event that the amplifier should dangerously overheat, sensing circuits shut down all channels until the amplifier cools down to a safe operating temperature. Normal operation is resumed automatically without the need for user intervention. Caution regarding heat escape should be exercised when mounting SA amplifiers. Exhaust cooling air is forced out through the rear of the chassis (see figure 3); make sure there is enough space around the back of the amplifier for this air to escape. SA amplifiers can be stacked one on top of the

other due to the efficient cooling system they are equipped with. There is however a safety limit to be observed: in case a rack with closed back panels is used, leave one rack unit empty every four SA amplifiers installed to guarantee adequate air flow.

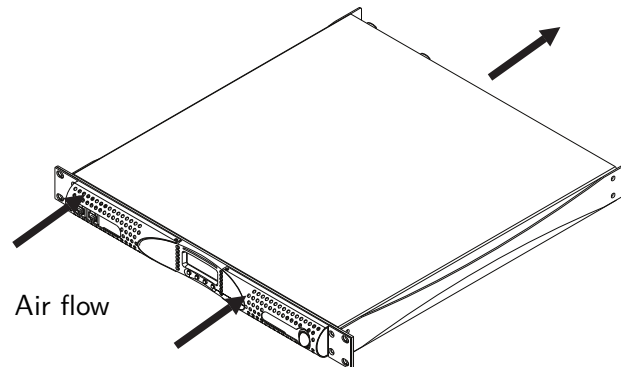

Figure 3: Front to rear airflow

#### 4.4 Operating Precautions

Make sure the power switch is off before attempting to make any input or output connections. Make sure the AC mains voltage used is within the acceptable operating voltage range specified in the SA amplifiers documentation (100V-240V \B110%). Damage caused by connecting the amplifier to an improper AC mains voltage is not covered by the warranty. By using good quality input and speaker cables, the likelihood of erratic signal behavior is reduced to a minimum. Whether you make them or buy them, look for good quality wires, connectors and soldering techniques.

#### 4.5 Grounding

There is no ground switch or terminal on the SA amplifiers. All shield terminals of input connections are directly connected to the chassis. This means that the unit's signal grounding system is automatic. In order to limit hum and/or interference entering the signal path, use balanced input connections. In the interests of safety, the unit must **always** operate with electrical safety earth connected to the chassis via the dedicated wire in the 3-wire cable. Never disconnect the ground pin on the AC mains power cord.

#### 4.6 AC Mains connection

The AC Main connection is made via the CPC type connector (IEC20A for SA30:2 and SA20:2) on the rear side of the panel. Figure 4 shows how to connect the mains power cable to the amplifier. Make sure the AC mains voltage used is within the acceptable operating voltage range specified in the SA amplifiers documentation (100V-240V \B110%). It is important to connect the ground for safety, do not use adapters that disable the ground connection. All SA amplifiers have an automatic power factor correction system for a perfect mains network interface. The amplifier is a resistive load for the mains network, minimizing the reactive power and the harmonic distortion on the current. The system allows performance to be maintained even in case of varying mains voltage.

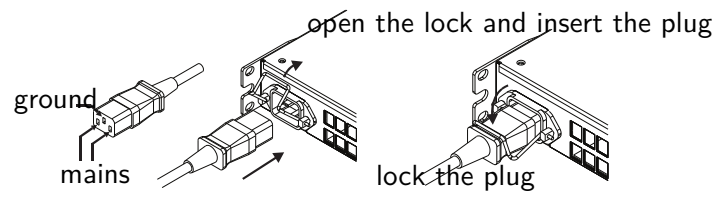

Figure 4: Mains connection

## 5 Connections and Operation

This chapter provides information on amplifier connection and operation. For optimal amplifier performance, it is important to understand the meaning of the information that the SA amplifier can provide regarding its status and configuration. This information is available to the user both via front panel indicators or via the Armonia client software when this is used. This chapter will break down all the front panel operations and monitoring functions the SA amplifier is capable of. The remaining part of the chapter will explain how to correctly connect the amplifier's inputs and outputs.

### 5.1 Connecting Audio Inputs

Input connections are made via the 3-pin XLR-female type or 1/4 phone Jack connectors on the rear side of the amplifier. The polarity is shown in figure 5.

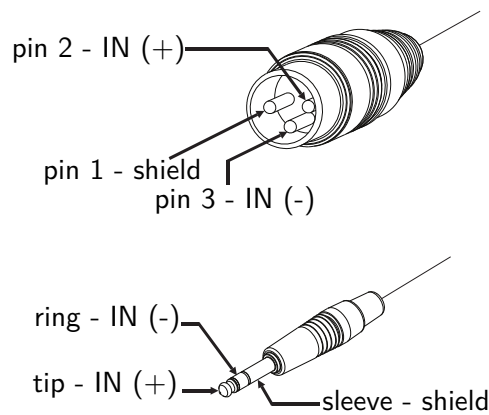

Figure 5: Audio input connections polarity

Figure 6 shows the connection of analog inputs for balanced or unbalanced line. You can use both configurations, but you must consider that unbalanced and long lines can introduce noise in the audio system. The Link On/Off switch located in the rear panel is for direct paralleling of the rear input connectors. The remaining input connectors can be used to carry signal to other amps.

#### XLR pinout chart

XLR Pin number	Assigned to
1	shield
2	hot (+)
3	cold (-)

#### Audio jack pin out summary

Connector element	Assigned to
sleeve	shield
tip	hot (+)
ring	cold (-)

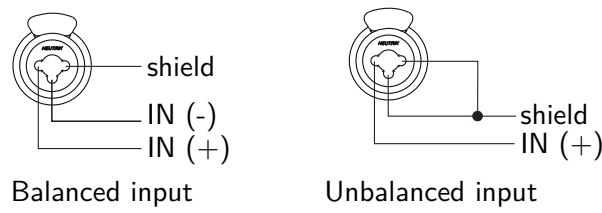

Figure 6: Balanced and unbalanced input connections

For SA30:2 and SA20:2 models, input connections are shown in figures 7 and 8 below; analog inputs for balanced and unbalanced lines are also available for these models.

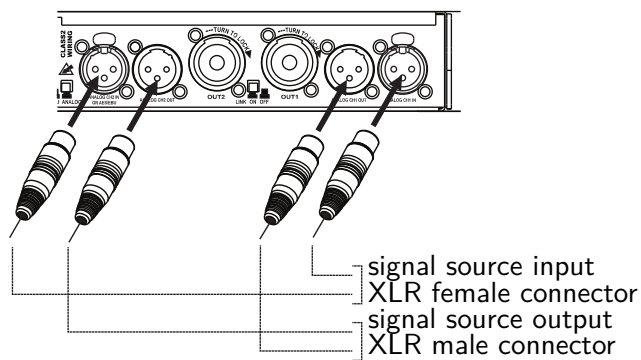

Figure 7: Audio input connections

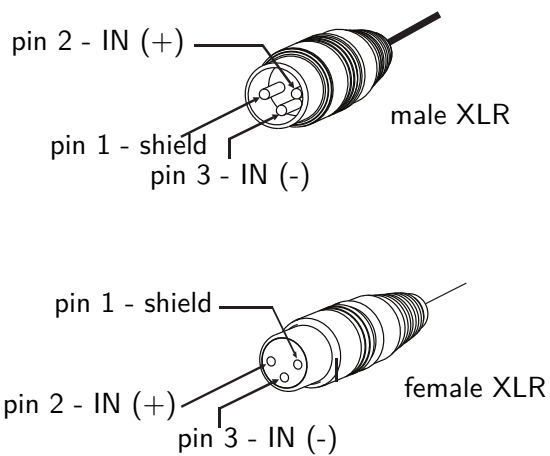

Figure 8: Audio input connections polarity

## 5.2 Connecting Audio Outputs

Audio output connections are made via Neutrik speakon connectors.

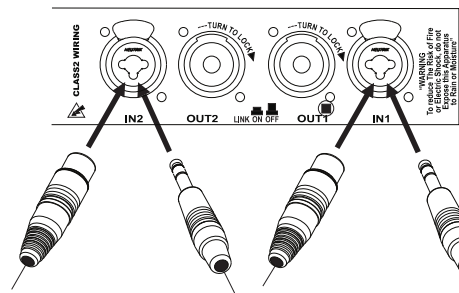

Figure 9: Audio output connector

Use suitable wire gauges to minimize power and damping factor losses in speaker cables. All SA amplifier outputs can also be configured to work in bridge mode. For each device, the 1+ and 2+ pins of speakon connectors are internally physically bridged together. They are the positive pole of the channel output. Pins 1- and 2- are also bridged together. They form the negative pole of the channel output.

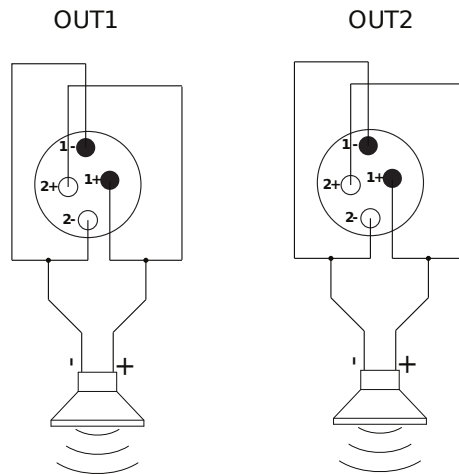

Figure 10: Audio input connection in stereo mode

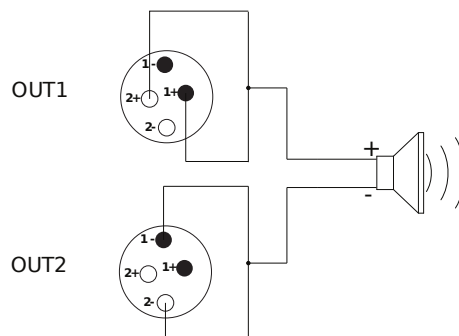

Figure 11: Audio output connection in bridge mode

### 5.3 Internal Signal Path Polarity

In order to increase the power's supply energy storage efficiency, signals coming from channels 1 and 2 are polarity reversed one with respect to the other when entering the amplifier. This



ensures a symmetrical use of the voltage rails: if, for example, both channels 1 and 2 input signals are going through a peak at the same time, channel 1's energy will come from the positive voltage rails while channel 2, whose polarity is reversed with respect to channel 1, will be fed energy from the negative voltage rails (see figure 12). In this manner, the power supply will work symmetrically, with one channel catered by the positive rails and the other by the symmetrical negative rails. Channel 2's signal will be polarity reversed once more to ensure that both channels output with the same polarity as their corresponding input signals. For this reason it is very important not to invert the polarity of either channels before feeding them to a SA amplifier. A double polarity inversion (the first by the user inserting the input signal and the other by the amplifier's internal circuitry) results in no inversion at all. If this were the case, both channels would be weighing on only one side (positive or negative) of the power supply's voltage rails. This would result in an inefficient use of the power supply's energy.

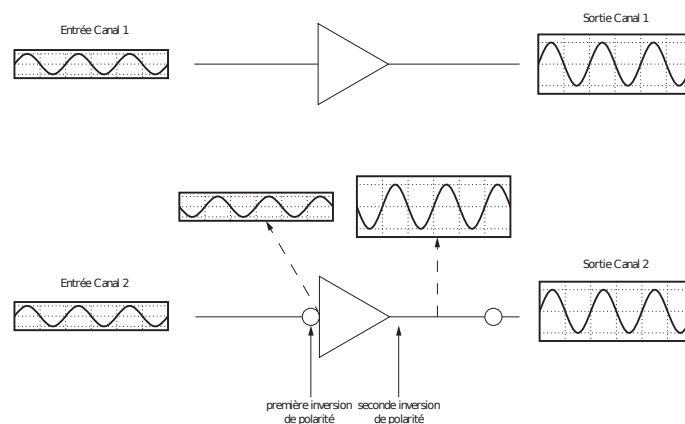

Figure 12: Internal signal path polarity with example input signals. Both channels 1 and 2 are fed the same sine signal

Please pay special attention in using balanced inputs on all measurement equipment (such as oscilloscope probes) when you are bench testing.

## 5.4 Remote Control Connection

### 5.4.1 V Ext

The "V Ext" terminal is used to remotely turn on, turn off or put in SA20:2 or SA30:2 amplifier. The "V Ext" signal reaches the amplifier via pin 2 of the rear Ethernet connector. When the V ext port is powered by an external 12 VDC 1A power supply, an internal controller is enabled to listen for incoming device power-on/off/standby commands.

Remote connection jack pinout chart:

1	GND
2	Vext
3	485-
4	485+
5	485+
6	485-
7	Vext
8	GND

### 5.4.2 Serial Connection

SA20:2 and SA30:2 amplifiers can be remotely controlled via an RS485 connection. Remote connection data cables must have an 8 pin modular plug to be inserted in the RJ45 jack labelled "DATAPORT" on the rear of the amplifier. By plugging an 8 pin modular plug and selecting the unit's remote ID via the rotary trimmers, the amp is ready to be remotely controlled. Please note that ID number 00 is not allowed. See figure 13 for details.

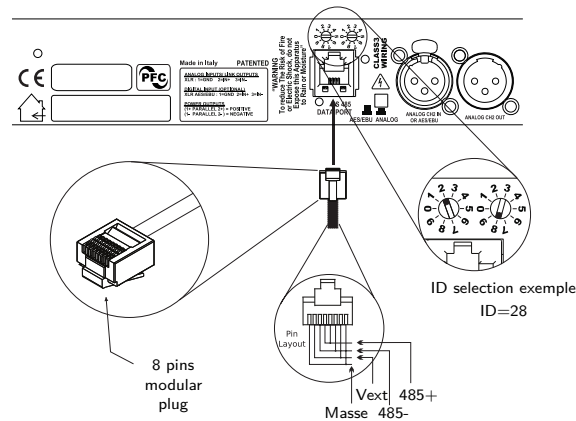

Figure 13: Remote connection jack, plug and ID selection

## 5.5 Amplifier configuration and setting

### 5.5.1 Introduction

In SA20:2 and SA30:2 amplifiers, the combination of the front panel buttons together with the LCD display allow the user access to detailed information and complete control over the amplifier's status. Each button has multiple functions and the display shows the current active function for each button. This chapter illustrates all the functions and settings accessible via the amplifier front panel. Figure 1 illustrates SA20:2 and SA30:2 front panel elements.

### 5.5.2 The main screen and the LED bars

When the amp is turned on, the main screen appears after a short presentation.

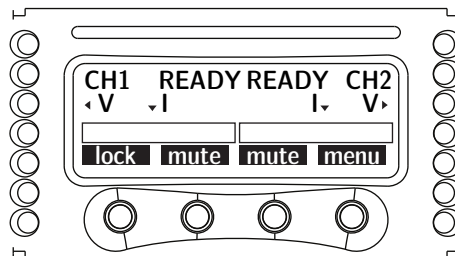



Figure 14: Main screen

The first line of the screen will read WAIT while the system undergoes an initial batch of internal tests to determine the status of the amp. If all parameters are normal, READY will replace WAIT on the display. System parameters are continuously monitored by the internal controller. If any parameter value should fall out of its correctly working range, a code error

relative to that particular parameter will appear on the third line of the LCD meter at the corresponding channel number. Should the parameter be out of range for both adjacent channels, the error code will appear in between the two compromised channels. The LED columns on the front of the amp can work as output voltage or current meters. When the LED bars are set to meter output voltage, for example, the meters on the LCD screen will indicate output current values. The vice versa is true : LED bars set as output current meters, LCD display bars become output voltage meters.

The single LEDs can have multiple functions:

LED Color	Solid color	Blinking
 Red	Channel output level has reached clipping limits OR channel has been muted for protection (1)	tone detection problem
 Yellow	temperature of power circuits is above 85°C OR output level (2) -2dB	power circuits temperature critical (80° - 85°C)
 Green	output level (2) -3dB	
 Green	output level (2) -6dB	
 Green	output level (2) -9dB	
 Green	output level (2) -15dB	
 Green	input signal is above -60dBV OR output level2 -18dB	

- (1) in case of a short circuit protection event, the LCD screen will read PROT
- (2) with respect to the output clipping threshold SA amplifiers gain sensitivity. Input signal: 1kHz sine wave. Voltage values are RMS:

## 5.6 Front Panel Buttons

The fourth line of the front panel LCD screen shows the functions of the buttons immediately below. A beep confirms that a button has been pressed; please note that this sound is not mutable. Pressing the button directly below the menu label on the LCD screen gives access to the amplifier's main menu. If an Armonía client is connected to the amplifier, a yellow blinking LED will appear in the software workspace view.

## 6 The main menu

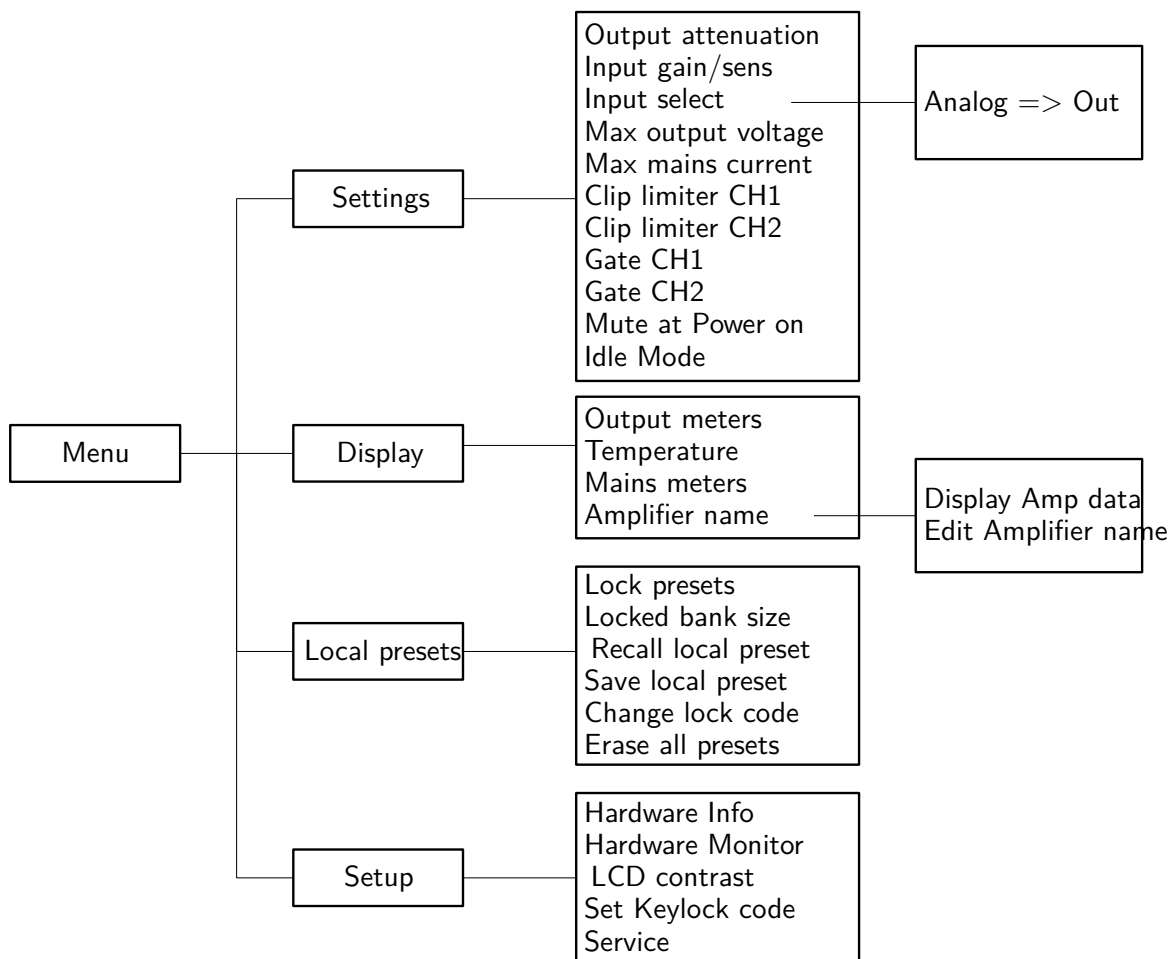

Figure 15: Main menu

The SA amplifiers main menu can be accessed by pressing the first button on the right, underneath the LCD label menu. figure 14 shows the button setup adopted to allow users to navigate the amp's internal menu. The up and down arrows allow to scroll the menu items. To access further menu voices branching off a specific menu item, select it and press the menu button once. Figure 15 shows the various submenus accessible from the main menu. Each menu function will be described in the following chapters. Some submenus in the SA amps require the user to set a numerical value for specific parameters using the front panel buttons. In order to speed this process up, these submenus dedicate two of the four available buttons to switching to a fast or slow parameter increment mode. When in the slow mode, the up and down arrows increase or decrease the parameter by a the smallest amount possible. The fast mode will increase or decrease the parameter value by an amount equal to 10 times the amount increased in the slow mode. For example :

- in "slow" mode: a single + button press will increase the Max mains current from 22 A to 23 A (figure 16)
- in fast mode: a single + button press will increase the Max mains current from 22 A to 32 A (figure 17)

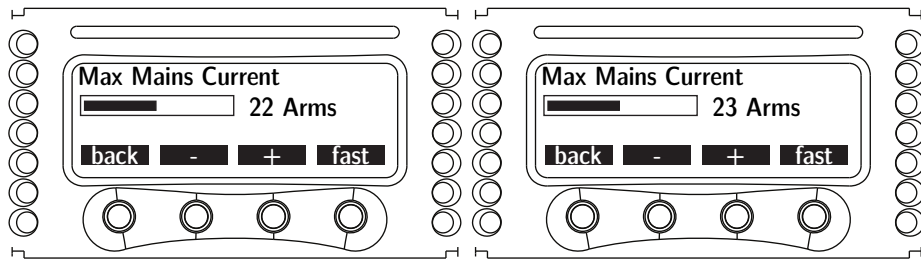

Figure 16: Slow parameter increase

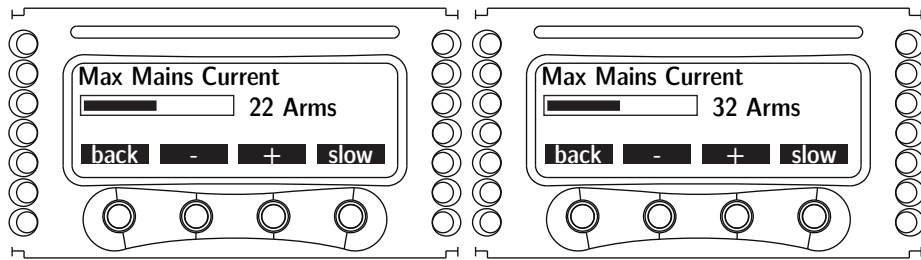

Figure 17: Fast parameter increase

## 7 Amplifier Settings

### 7.1 Output attenuation

The output attenuation screen sets the amplifier's output attenuation level. The user can choose whether to set output attenuation for channel 1, channel 2 or both by cycling through the right most button. The + and - buttons change the value of the output attenuation in the range from 0 to -30dB. A single + or - button press will increase or decrease the output attenuation by 1dB.

**Note** For ideal sonic performance, select a 0dB output attenuation (meaning no attenuation), and select the proper gain/sensitivity level as explained in the next paragraph.

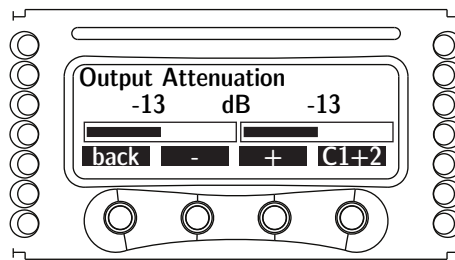

Figure 18: Output attenuation

### 7.2 Input Gain/Sensitivity

All SA amplifiers allow selection of input sensitivity to allow correct sensitivity matching with other third party equipment. The user can choose whether to set the input gain/sensitivity for channel 1, channel 2 or both by cycling through the right most button. The + and - buttons change the value of the input gain and corresponding sensitivity. The allowed gain values are 26dB, 29dB, 32dB and 35dB. The table below shows the input sensitivity values for the SA amplifiers. These are the maximum RMS voltage values of an input 1kHz sine wave before clipping occurs at the output stage. These values are reported with respect to the amplifier's gain.

Gain (dB)	SA20:2	SA30:2
26	4.48	5.30
29	3.17	3.75
32	2.47	2.66
35	1.59	1.88

The maximum balanced input signal before saturation of the input stage of the amplifier occurs with respect to the amplifier's gain is presented in the chart below. These are the maximum RMS voltage values of an input 1kHz sine wave

Gain (dB)	dBV	dBu	VRMS
26	25,0	27	18
29	21,6	24	12
32	19,0	21	9
35	15,6	18	6

**Note** All APG products are calibrated to work with 26 dB gain amplifiers.

### 7.3 Input select

SA amplifiers allow the user to choose only one analog input modes. For AES3 inputs, please contact APG to know which options are available.

### 7.4 Max output voltage

The max output peak voltage of SA amplifiers can be set by the user. It is possible to set output peak voltage levels for channel 1, channel 2 or both by pressing the C1+2 button. The + and - buttons change the value of the max output peak voltage.

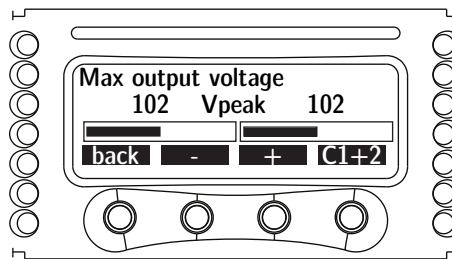

Figure 19: Max output voltage screen

The ranges available are shown in the table below:

Amplifier model	Peak output voltage (V)
SA20:2	40 to 140
SA30:2	40 to 165

### 7.5 Max mains current

The maximum current the amplifier can draw from the mains can be set by the user through the front panel of all SA amplifiers.

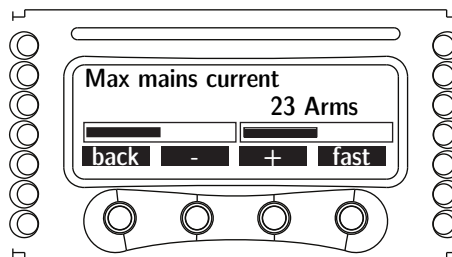

Figure 20: Max mains current set up screen

The + and - buttons allow setting of the value of the max rms mains current. Acceptable values are within the 8 A to 16 A for SA20:2 and SA30:2. Setting the maximum mains current determines the current threshold at which a C-Type current breaker will trip.

## 7.6 Clip Limiter CH1 - CH2

The clip function can be used to prevent distortion caused by clipping of the excessive output signal amplitude. This feature can be disabled or enabled by pressing the on/off button in the when the clip limiter voice is selected in the Amplifier settings menu

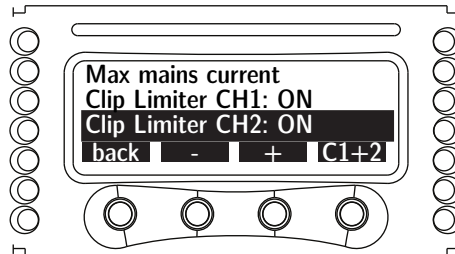

Figure 21: Clip limiter setting for channels 1 and 2 separately

Please note that clip limiters can be set independently for both channels.

**Caution** Disabling clip limiters can potentially damage loudspeakers. The amplifier's internal clip limiters should not be deactivated unless the limiting function is implemented by an external device such as digital system controllers. In this case, it is extremely important to correctly set limiting parameters in order to preserve loudspeakers from excessively powerful and potentially hazardous driving signals.

## 7.7 Gate CH1 - CH2

This function allows to mute the amplifier channels individually if the input signal amplitude falls below the values shown in the following table:

Gain (dB)	dBV	dBu
26	-54	-52
29	-57	-55
32	-60	-58
35	-63	-61

This function can be enabled and disabled by pressing the right most front panel button corresponding to the on or off label.

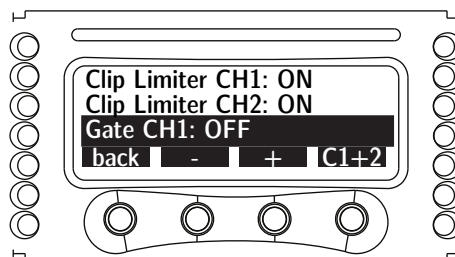

Figure 22: Single channel output gate selection screen

Gating the output is delayed by 5 seconds after the input signal falls below the threshold. If the channel is muted, the bottom green LED in the corresponding front panel LED column is off.



## 7.8 Mute At Power On

This function allows the user to automatically mute all channels when the amplifier is turned on. Toggle the on or off status by pressing the front panel button below the sel label.

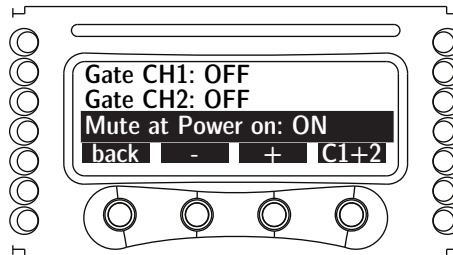

Figure 23: Mute at Power on selected

If this function is enabled, a Muted label will appear at the main screen next to each channel at the next power on. Press the button underneath the mute label in the front screen to unmute the channel.

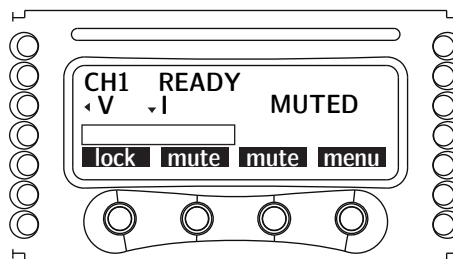

Figure 24: Right channel muted, left channel unmuted. Toggle mute status by pressing the "mute" button

Toggle mute status by pressing the mute button

## 7.9 Idle Mode

The idle mode function is a power saving feature. When this function is activated, the output stage is turned off after no input signal greater than -60dBV approximately is detected for a user selectable amount of time, saving about 40W of power per channel (see the table in 7.7 Gate CH1 - CH2 on page 24 for the exact wake up from idle voltage values) This results in reduced heating, longer amplifier and fans life, and, especially for fixed installations which are permanently turned on, a lower electricity bill. Exiting from idle mode is quasi-instantaneous. In order to set the time after which the amplifier enters in idle mode, push the right most button labelled sel when the idle mode line is highlighted. This will open the Idle state timeout screen. Using the central buttons, select the desired time. In the slow mode, a single button press will increase or decrease the time by one minute. The fast mode will bring this up to 10 minute steps. The timeout range goes from 0 to 720 minutes.

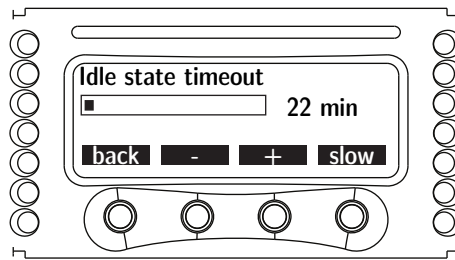

Figure 25: Idle state timeout

## 8 Display

### 8.1 Output Meters

The output meters screen shows important output signal information for the amplifier. By pressing the right most front panel button, the screen view is toggled between information relative to channel 1, channel 2 or relative to the sum of channels 1 and 2. The top line in this screen displays the RMS voltage value of the output, both as a number as well as a horizontal meter bar. The second and third line display the output RMS current and power level respectively. The output power reported is a peak value reading taken every 200 ms. The bottom line of the screen displays the load impedance as Zload. The minimum output voltage is stored internally and available to remote clients connected to the amplifier. The load impedance is indirectly inferred by a successive approximations. Time between single output impedance approximations depends on the output signal: the greater the amplitude of the signal, the shorter the time interval between measurements needed to approximate the output impedance, the faster the successive approximation method will converge to the true impedance value.

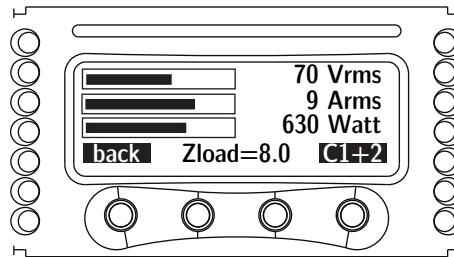

Figure 26: Output meters screen for a bridged channel 1/channel 2 connection . Measured load impedance in this example is 8 Ohms

### 8.2 Temperature

This screen displays the current amplifier temperature.

**Note** In the C1+2 mode, the RMS voltage and power readings displayed are the average RMS voltage and peak power of each channel. The RMS current value, on the other hand, is the sum of each single channel's RMS current level.

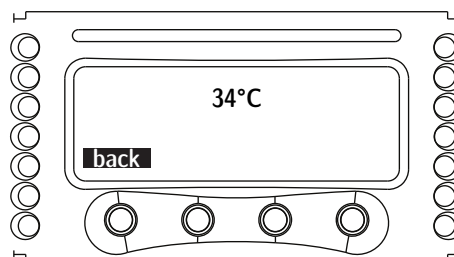

Figure 27: Current amplifier temperature

### 8.3 Mains meters

This screen displays the updated mains RMS voltage and RMS current levels. Values are displayed in numbers and as progress bars.

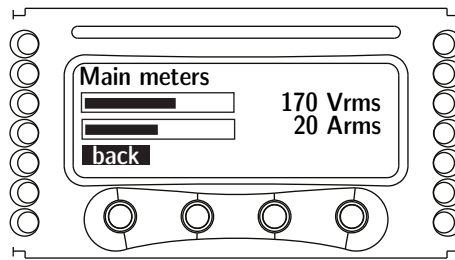

Figure 28: Updated mains RMS current and voltage values

**Please note** The current and voltage levels displayed in this screen are approximate values, which serve the purpose of giving a general indication of the mains levels. Please refer to other sources (such as calibrated multimeters) for reliable and exact mains voltage and current measurements.

#### 8.4 Amplifier Name

The Amplifier Name menu gives access to two menu branches: the Display Amp data function and the Edit Amplifier name menu. When the Display Amp data function is activated, the main amplifier screen shows the amplifier name (20 characters, bold) blinking to a second screen showing the current selected preset name (40 characters). If the preset has been altered in any way, the displayed preset name will have a Modified prefix to indicate this. The amplifier name can be assigned by entering the Edit amplifier name menu. For information regarding on-screen text editing, please see 9.4 Save local preset on page 30.

## 9 Local presets

All SA amplifiers have an on board memory capable of storing up to 50 presets. An amplifier preset is a snapshot of the current amplifier status, that is to say the basic amplifier settings.

### 9.1 Locked presets

When the locked presets function is active, a number of presets, determined by the Locked bank size menu, is not over writable. This function's status can be toggled on/off by entering the Lock code. For instructions on how to enter and edit text, please see section 9.4 Save local preset on page 30.

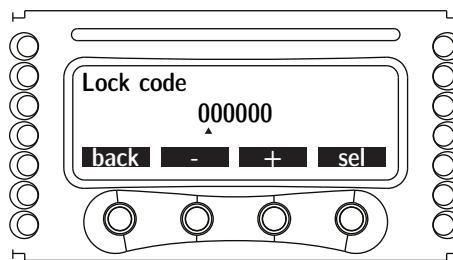

Figure 29: Enter the lock code. Select correct digit by using “+” and “-” buttons. Move to the digit to the right by pressing the “sel” button

If the wrong code is entered, the system simply returns to the previous local presets menu.

### 9.2 Locked bank size

This menu allows the user to set the number of locally stored presets that cannot be overwritten. Either all (50) or none (0) of the presets can be locked. After entering the correct lock code, select the number of presets to be write protected.

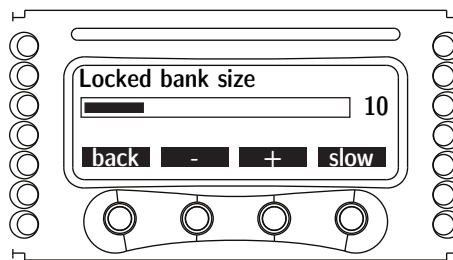

Figure 30: Change the number of locked presets by pressing the “+” or the “-” buttons. The slow editing mode uses one preset steps; the fast mode uses 10 presets steps.

When done, press the left most button labelled ok to return to the previous screen.

### 9.3 Recall local preset

In order to recall on of the 50 locally stored presets, press ok when the Recall local preset line is highlighted. Then use the middle buttons to navigate forwards or backwards in the existing presets list. If a preset number is not used, it is labelled <empty>. Once the desired preset has been found, press the right most button labelled ok to load it.

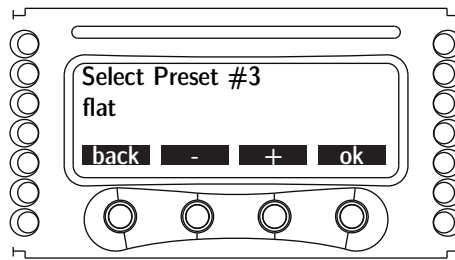

Figure 31: Preset number 3, named "flat" is selected. To load it, press "ok". Press "back" to return to the previous screen.

Press ok. Press back to return to the previous screen. Once the preset has been loaded correctly, press the left most button labelled back to return to the local presets menu.

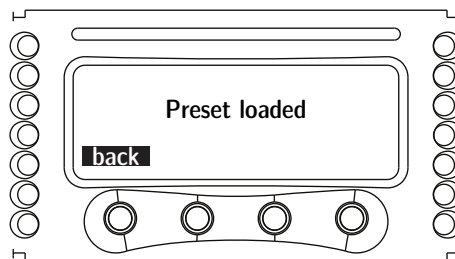

Figure 32: The chosen preset has been loaded correctly. The amplifier's current settings match those store in the loaded preset

## 9.4 Save local preset

Save to an empty slot To save a current amplifier setup as a preset to the local memory, enter the Save local preset menu. Select an non used preset which is labelled empty:

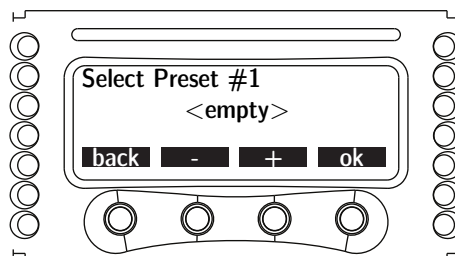

Figure 33: Preset memory location number 1 is empty

After pressing ok, the user is asked whether to keep the current preset name or change it. The current preset name will be followed by the selected memory slot name if no other preset has been loaded in the amplifier either via remote control or using a SmartCard.

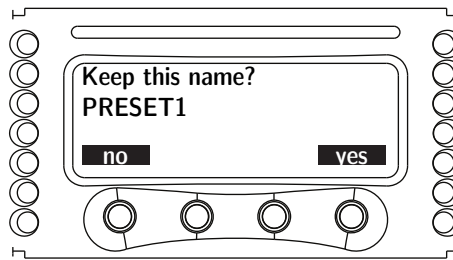

Figure 34: Pressing “yes” will write the current setup to preset number one and will name it “PRESET 1”. Pressing “no” will allow the user to change the preset name

By pressing no, the preset name can be edited. The preset name can be edited one character at a time. The arrow points towards the active character that is currently being edited. To move from one character to the next, press the sel button. The + and - buttons allow to navigate within a standard set of capital letters and basic punctuation marks.

Figure 35: List of available characters

When the preset has been correctly saved with the name entered by the user entered, a confirmation screen will appear (see figure 36).

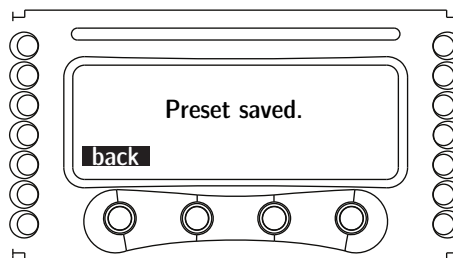

Figure 36: Preset saved confirmation screen

## 9.5 Overwriting an existing preset

If the preset location is not empty, the amplifier will ask the user confirmation to overwrite the file. Note that if you have already input a preset name, or if you have loaded a preset from local memory or a SmartCard, the name is used as starting point for a new save preset operation. For example, suppose that a preset named 18IN SUB 1 has been loaded from a SmartCard with the purpose of saving it in the amplifier’s local memory in the preset slot number 3, as show in figure 37.

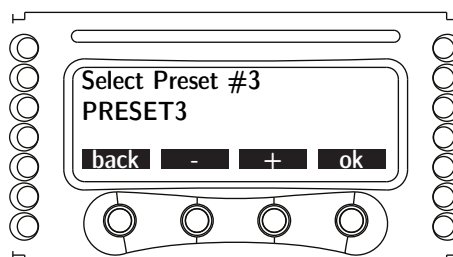

Figure 37:

In this case the amplifier asks the user whether to keep the preset's name as loaded from the SmartCard or change it. This is useful for copying presets from/to SmartCard.

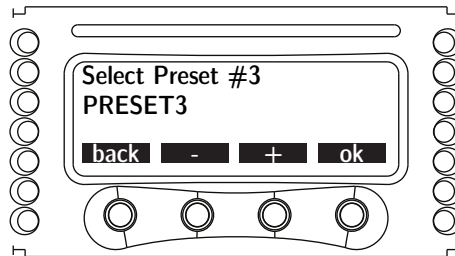

Figure 38: Preset slot number 3 being selected to accommodate the preset loaded from the SmartCard

By pressing no the system will enter in a text editing mode, allowing the user to choose a preset name. For details on text editing, see section 9.4 Save local preset on page 30. By pressing yes, the user is prompted to confirm the intention of overwriting the preset.

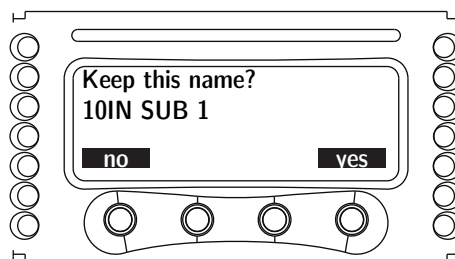

Figure 39: Keep this name confirmation screen

Pressing ok will confirm the overwrite. Once the preset has been correctly saved a screen will inform the user of this (see figure 36). Pressing back will return the user to the previous screen to select another memory slot in which to save the current preset.

## 9.6 Change Lock Code

In order to change the lock code used to activate the Lock presets function, the old user code must be entered. Enter the code by following the text editing procedure described in the Save Local Preset section. Press ok when the code has been completely entered. If the entered code is correct, another screen will prompt the user to enter then new lock code. If the entered code is incorrect, the system returns to the previous screen. There is no limit on the number of times that an incorrect lock code can be entered.

## 9.7 Erase all presets

This function allows to erase all non write protected presets in the amplifier's internal memory. After having selected this function's submenu by pressing ok, a confirmation screen will appear.



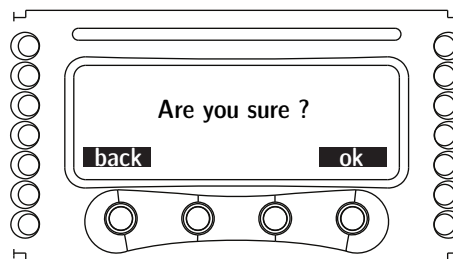

Figure 40: This screen prompts the user to confirm overwriting an existing preset slot

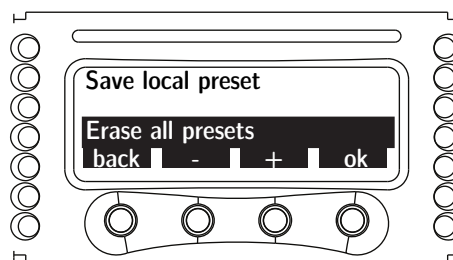

Figure 41: Press "ok" to select the "erase all presets" submenu

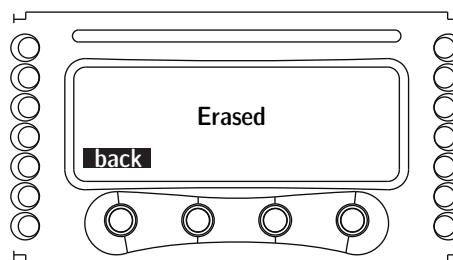

Figure 42: All presets have been erased

Please press back to return to the local presets menu.

## 10 Setup

### 10.1 Hardware info

This menu allows the user to access various information about the amplifier's hardware. The first screen shows the amplifier name followed by:

**S/N** Serial number of the amplifier

**Hw ID** Hardware ID, selectable via the rotary encoders on the back panel Pressing the more button on the screen allows to cycle through a greater number of pages containing more information; the back button will bring the user back to the previous setup menu.

**KFRNT** This is the front panel version

**KCTRL** Controller version number

**Lifetime** Operating hours of the amplifier.

### 10.2 Hardware monitor

This menu allows the user to access information about the current amplifier system parameters. These are:

**PWRBSCH1** amplifier's power supply voltage for channel 1

**PWRBSCH2** amplifier's power supply voltage for channel 2 Pressing the more button on the screen allows to cycle through a greater number of pages containing more information; the back button will bring the user back to the previous setup menu.

**VAUX** internal auxiliary voltage

**+5VAN** auxiliary analog voltage

**VEXT** external remote control voltage

**VAUX** indicates if the power supply auxiliary voltage is correct

**IGBTCONV** indicates the DC/DC converter monitor status

**VBOOST** internal post PFC voltage

**192KHZ** system clock frequency status

### 10.3 LCD contrast

This screen allows the user to set the LCD display contrast using the + and - buttons.

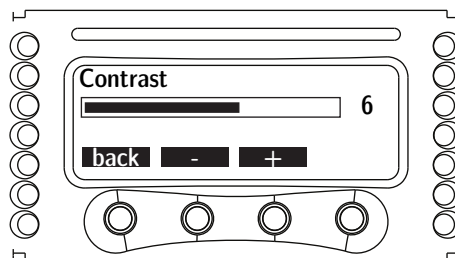

Figure 43: Setting screen for the LCD display contrast

## 10.4 Key Locking and Setting

In order to prevent the amplifier's settings from being altered by acting on the front panel commands, the lock function can be activated if the corresponding button is held pressed for more than 1 second; in this case all other buttons are locked. Unlocking buttons is done in the same way, but an unlock code is required for security reasons. In order to enter an unlock code for the amplifier, select the Set Keylock Code from the Setup Menu. Please note that this screen can also be accessed by pressing the unlock button in the main screen when the amp is in locked key mode. Using the two central buttons, choose and set an unlock code. Pressing the right most key (labelled sel) allows to select the desired digit.

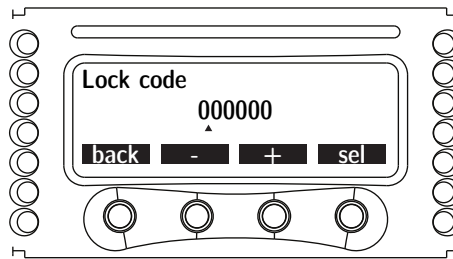

Figure 44: Setting the keylock code screen

## 10.5 Single Channel Muting

Muting of one channel at a time can be done via the mute function directly from the amplifier's front panel. Pressing the button directly below the mute label can mute each channel individually; in this case, the on screen channel-specific parameters are replaced by the muted label. Unmuting the channels is done by pressing the mute button again.

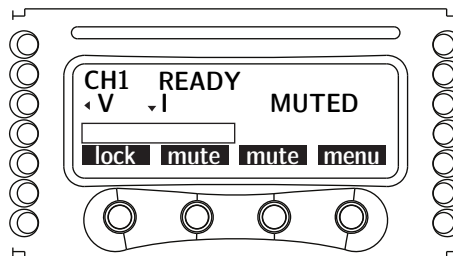

Figure 45: Example of a muted right channel. To unmute the channel, press the right most "mute" button again

## 11 Protection

In order to protect your device and your speakers from accidental damage, SA amplifiers include an extensive automatic protection system. In the following sections, potentially dangerous scenarios and the amplifiers' corresponding protective response are explained in detail.

### 11.1 Turn-On/Turn-Off muting

For about four seconds after turn-on, and immediately at turn-off, the amplifier outputs are muted. Class D amplifiers may cause severe speaker damage at power up due to the high voltage levels at the output stage. In order to avoid this, the outputs are muted for about 4 seconds after turn on. Similarly, turning off the amplifier can cause the same problem: outputs are muted immediately at turn off.

### 11.2 Short circuit protection

Short circuits or very low impedance loads may destroy the output stage of any amplifier. In order to protect the amplifier from the dangerously high current surges arising from accidental output short circuits or low impedance loads, all SA amps block channel activity when the current drawn from the load rises above a set value. In case of short circuit, the topmost front panel red LED will light-up. At the same time, the PROT warning appears in the first line of the LCD display. The channel is muted for 2 seconds after which the amplifier will check whether the current draw is still over the safety threshold. Should this be the case, the amplifier will mute the channels for another 2 seconds and the procedure will reiterate. The amplifier will therefore automatically self-reset every 2 seconds. Once the amplifier has undergone 50 resets, and the output current draw is still above safe limits, the unit enters a permanent protection mode: an on/off cycle is needed to restart the unit and restore it to full functioning mode. The red LED will be turned off and the amplifier will return to normal operating conditions only when the output current draw returns to acceptable levels.

### 11.3 Thermal protection

All SA amplifiers use a continuously variable speed fan to assist cooling (the fan speed changes in response to the amplifier's cooling needs). If the heat sink temperature reaches approximately 80°C, the yellow front panel LED starts blinking. If the temperature should rise above 85°C the thermal sensing circuitry will mute each power section channels, the yellow LED will be steadily on, and the power supply will be cut off. At the same time, the PROT warning appears in the first line of the LCD display. Once the heatsink has cooled down, the amplifier will automatically reset and the yellow LED will go off. One possible way to reduce the temperature is to reduce the output power.

### 11.4 DC fault protection

In order to protect your speakers from mechanical damage caused by a DC signal coming from the amplifier's output, a DC detection circuit is placed between the amplifier's output stage and power supply. If a DC signal or excessive subsonic energy appears at a channel output an instantaneous protection circuit will cut off the power supply to both channels. Power supply shutdown is used instead of speaker relays in order to improve the damping factor and reliability of SA amplifiers. At the same time, the PROT warning appears in the first line of the LCD display.

### **11.5 Input/Output protection**

An ultrasonic network decouples radio frequencies from the outputs keeping the amplifier stable with reactive loads and protects the loudspeakers against strong very high frequency nonmusical signals above the audible range.

## 12 User Maintenance

### 12.1 Cleaning

Before attempting to clean any part of the amplifier, first disconnect the AC main source. Use a soft cloth and mild nonabrasive solution to clean the faceplate and chassis.

**warning.pdf** Never let any liquid reach the internal parts of the amplifier.

### 12.2 Service

There are no user-serviceable parts in your amplifier. Refer servicing to qualified technical personnel. APG has an in-house service departments. If your amplifier needs repair contact the APG Technical Service at [sav@apg.tm.fr](mailto:sav@apg.tm.fr).

### 12.3 Dust Removal

In dusty environments, the front side air filters clog with dust after prolonged use. The dust gathered in the filters will interfere with cooling. You may use compressed air to remove the dust from filters.

To remove air filters:

1. First unscrew the 2 M2 5X8 screws at the sides of the frontal panel
2. Rotate the covering grill
3. Repeat the same operation for the other covering grill cover grill screw filter

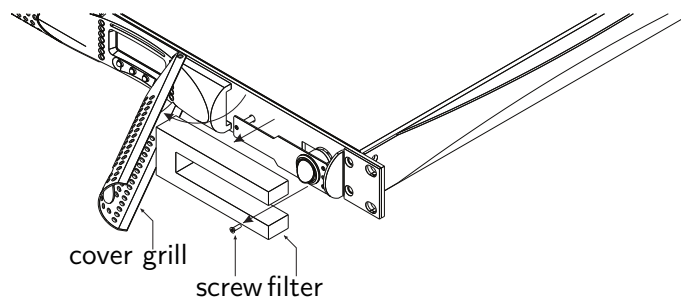

Figure 46: Air filter removal

Air filter cleaning should be scheduled according to the dust levels in the amplifier's operating environment.

## 13 Warranty Product

APG guarantees its manufactured products to be free from defective components and factory workmanship for a period of 48 (forty eight) months, starting from the date of purchase printed on APG invoice to the end customer. All warranty repairs and retrofits must be performed at APG facilities at no cost for the purchaser.

- **Warranty exclusion:** APG's warranty does not cover product malfunctioning or failure caused by: misuse, abuse, repair work or alterations performed by non-authorized personnel, incorrect connections, exposure to harsh weather conditions, mechanical damages (including shipping accidents), and normal wear and tear. APG will perform warranty services provided that the product is not damaged during transportation.
- **Return of Goods:** Goods can be returned to APG only after they have been granted a Return Merchandise Authorization (RMA) number to be attached to the external packaging. APG (or its Authorized Service Center) has the right to refuse any returned good without a RMA number.
- **Repair or replacement:** APG reserves the right to repair or replace any defective goods covered by product warranty at its sole discretion and as it deems best.
- **Cost and responsibility of transport:** The purchaser (or end user/customer) is solely responsible for all transportation costs and risks associated with sending warranty covered goods to APG. APG will assume full responsibility and cover all costs incurred to send the goods back to the purchaser (or end user/ customer).

## 14 Assistance

Even though most product malfunctioning can be solved at your premises through APG Customer Care or your direct knowledge, occasionally, due the nature of the failure, it might be necessary to return defective products to APG for repair. In the latter case, before shipping, you are kindly asked to follow step by step the procedure described below :

- Obtain the "Defect Report Form" contacting our Customer Care Department via email: [sav@apg.tm.fr](mailto:sav@apg.tm.fr).
- Fill out one "Defect Report form" for each returned item (the form is an editable tab guided document) and save as your name, amp model and serial Number (for example: `distributornamek10sn17345.doc`) providing all required information except the RMA code/s and send it to [er@apg.tm.fr](mailto:er@apg.tm.fr) for APG approval.
- In case of defect reports approved by the APG Customer Service Representative you will receive an RMA authorization code (one RMA code for each returning device). Upon receiving the RMA code you must package the unit and attach the RMA code outside the pack, protected in a waterproof transparent envelope so it is clearly visible.
- All returning items must be shipped to the following address:

APG France  
 19 bis Route des Ecoles  
 95500 Le Thillay  
 FRANCE

In case of shipment from countries NOT belonging to the European Community make sure you have also followed the instructions described in the document : TEMPORARY EXPORTATION/IMPORTATION PROCEDURE.

Thank you for your understanding and cooperation and continued support as we work to improve our partnership.

## 14.1 Amplifier Error Codes

The error code value displayed in the main screen is the sum of the single error code values. An error occurs when the following voltage values or power conditions fall outside normal ranges.

Error Code	Error Description
1	192 kHz clock not present
2	Positive 15V aux
4	Negative 15V aux
8	Positive 5V analog
100	Negative power bus CH1
200	Negative power bus CH2 2000 Positive power bus CH1
4000	Positive power bus CH2
8000	External auxiliary voltage
Check rail fuses	Check rail fuses CH1 and CH2

For example: 4301=4000+200+100+1 means there are 4 distinct errors

- Positive power bus CH2
- Negative power bus CH2
- Negative power bus CH1
- 192KHz clock not present

## 14.2 SmartCard function

A maximum of 150 presets can be easily stored in a standard-sized SmartCard. Please note that SmartCards for SA presets must be initialized by APG. In order to access the SmartCard menu, simply insert the card in the amplifier as shown in figure 47.



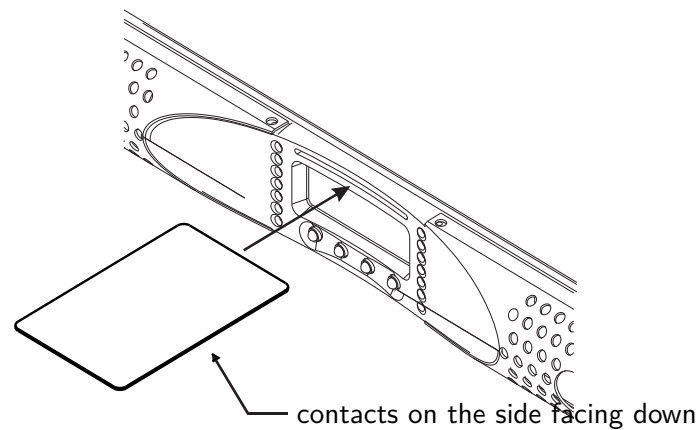

Figure 47: Smart Card insertion in the front panel slot

The main SmartCard menu will allow the user to save or recall presets stored on the card. Please see 29 Local presets page 29 for instructions on how to store and load presets in SA amplifiers.

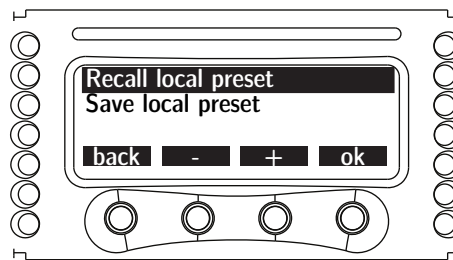
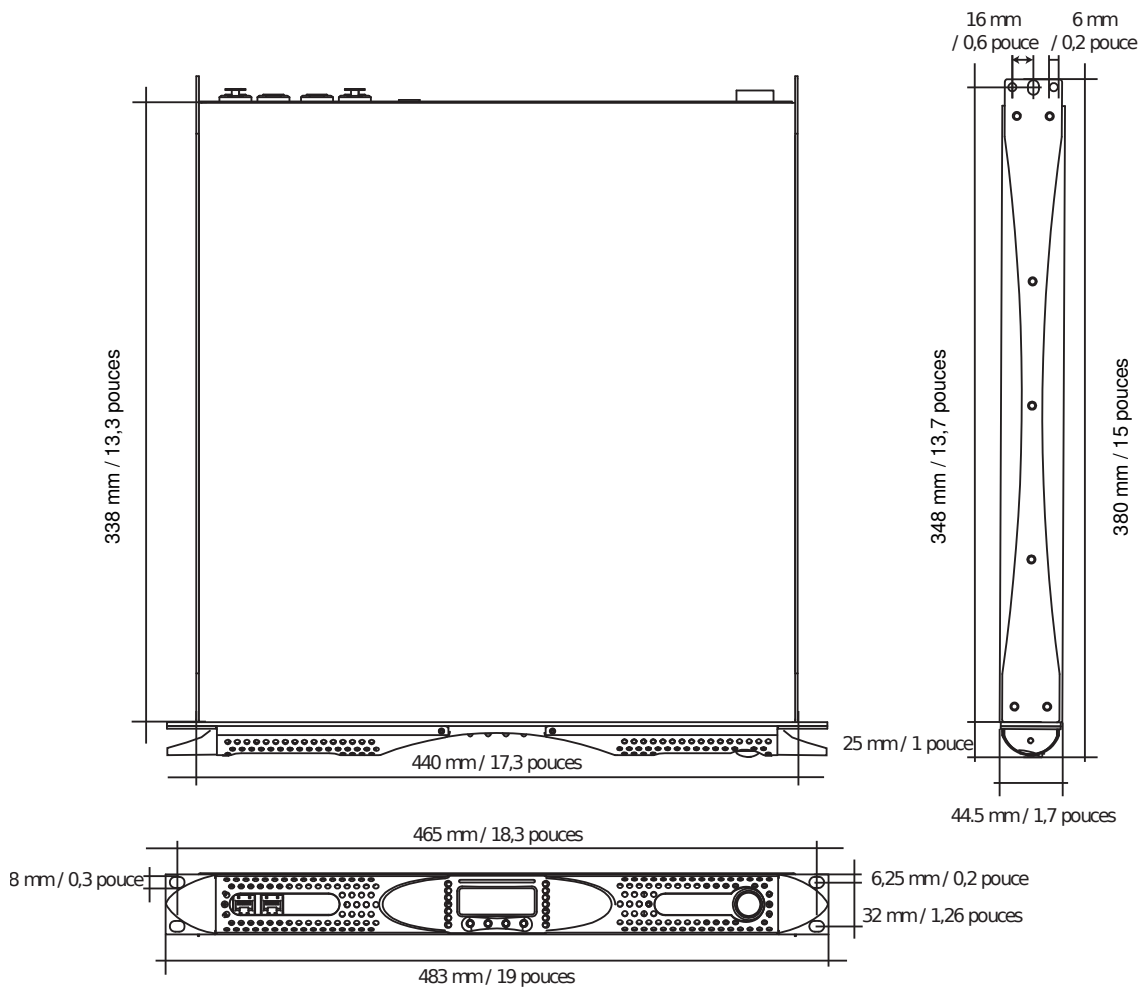

Figure 48: The main SmartCard menu is visible when the card is inserted in the amplifier's frontal slot

**Please note** If the inserted card is blank, the "Recall local preset" option will not be displayed in the main SmartCard menu.

## 15 Technical specifications



## SA20:2

General																	
Number of channels	2																
Output power EIAJ standard test, 1 kHz, 1% THD	<table border="1"> <thead> <tr> <th colspan="3">Stereo mode</th> <th colspan="2">Mono bridged mode</th> </tr> <tr> <th>2 Ω/ch</th> <th>4 Ω/ch</th> <th>8 Ω/ch</th> <th>4 Ω</th> <th>8 Ω</th> </tr> </thead> <tbody> <tr> <td>2,400W</td> <td>1,950W</td> <td>1,000W</td> <td>4,800W</td> <td>3,900W</td> </tr> </tbody> </table>	Stereo mode			Mono bridged mode		2 Ω/ch	4 Ω/ch	8 Ω/ch	4 Ω	8 Ω	2,400W	1,950W	1,000W	4,800W	3,900W	
Stereo mode			Mono bridged mode														
2 Ω/ch	4 Ω/ch	8 Ω/ch	4 Ω	8 Ω													
2,400W	1,950W	1,000W	4,800W	3,900W													
Max. output voltage	140 V(peak)																
Max. output current	102 A(peak)																
AC mains power																	
Power supply	Universal, regulated switch mode with PFC (Power Factor Correction)																
Operating voltage	100-240 V ±10%, 50/60 Hz																
Power factor cos (Φ)	>0.95 @ >500 W																
Consumption / current draw	<table border="1"> <thead> <tr> <th colspan="2">@ 230 V</th> <th colspan="2">@ 115 V</th> </tr> </thead> <tbody> <tr> <td>Idle</td> <td>112 W</td> <td>0.57 A</td> <td>1.14 A</td> </tr> <tr> <td>1/8 of max out power @ 4Ω</td> <td>609 W</td> <td>3.1 A</td> <td>6.3 A</td> </tr> <tr> <td>1/4 of max out power @ 4Ω</td> <td>1,219 W</td> <td>5.7 A</td> <td>11.4 A</td> </tr> </tbody> </table>	@ 230 V		@ 115 V		Idle	112 W	0.57 A	1.14 A	1/8 of max out power @ 4Ω	609 W	3.1 A	6.3 A	1/4 of max out power @ 4Ω	1,219 W	5.7 A	11.4 A
@ 230 V		@ 115 V															
Idle	112 W	0.57 A	1.14 A														
1/8 of max out power @ 4Ω	609 W	3.1 A	6.3 A														
1/4 of max out power @ 4Ω	1,219 W	5.7 A	11.4 A														
Thermal																	
Operating temperature	0-45° C / 32-113° F																
Thermal dissipation	Fan, continuously variable speed, temperature controlled																
Idle	382 BTU/h 96 kcal/h																
1/8 of max out power @ 4Ω	722 BTU/h 182 kcal/h																
1/4 of max out power @ 4Ω	1,062 BTU/h 268 kcal/h																
Audio																	
Gain (selectable)	26 dB      29 dB      32 dB      35 dB																
Input sensitivity @ 8Ω	4.48 V      3.17 V      2.47 V      1.59 V																
Max input level	27 dBu      24 dBu      21 dBu      18 dBu																
Gate	-52 dBu      -55 dBu      -58 dBu      -61 dBu																
Input impedance	10 kΩ balanced																
Frequency response	20 Hz - 20 kHz (1 W @ 8 Ω, ±0.5 dB)																
THD+N / SMPTE & DIM100 IMD	<0.2% from 1 W to full power (typically <0.05%)																
S/N ratio	>106 dBA (20 Hz - 20 kHz, A weighted)																
Crosstalk separation	>70 dB @ 1 kHz																
Slew rate	50 V/μs @ 8 Ω. input filter bypassed																
Damping factor	>5000 @ 20 - 200 Hz																
Front panel																	
Indicators	7 meter LEDs																
Controls	4 pushbuttons + mains switch																
Maintenance	SmartCard reader/writer.																
Rear panel																	
Audio input connectors	Analog: 2 × balanced Neutrik® XLR female; AES3: use channel 2 × LR																
Audio output connectors	Analog: 2 × balanced Neutrik® XLR male																
Speaker output connectors	2 × Neutrik® Speakon NL4MD																
Network data port RS485	1 × RJ45 with 2 recessed rotary encoders for ID selection																
Aux voltage	1 × 2-pin Phoenix P. 3.81mm																
AC mains	IEC20A with IEC20A Schuko for EU, IEC20A/American 15A pin plug																
Controls	1 × link switch, linking analog inputs 1 and 2, AES3/analog input switch																
Construction																	
Dimensions	W 483 mm / 19", H 44.5 mm / 1U, D 380 mm / 15"																
Weight	8kg / 17.7 lbs																

## SA30:2

Generals					
Number of channels	2				
Output power	Stereo mode			Mono bridged mode	
EIAJ Test Standard, 1 kHz, 1% THD	2 Ω/ch	4 Ω/ch	8 Ω/ch	4 Ω	8 Ω
Max output voltage / current	2,800W	2,600W	1,400W	5,600W	5,200 W
	165 V <sub>peak</sub> / 102 A <sub>peak</sub>				
AC Mains Power					
Power supply	Universal, regulated switch mode with PFC (Power Factor Correction)				
Operating voltage	100-240 V ±10%, 50/60 Hz				
Power factor	cos (f) >0.95 @ >500 W				
Consumption / current draw	@ 230 V		@ 115 V		
Idle	112 W	0.57 A	1.14 A		
1/8 of max out power @ 4Ω	813 W	4 A	8 A		
1/4 of max out power @ 4Ω	1,625 W	7.4 A	14.8 A		
Thermal					
Operating temperature	0° - 45° C / 32° - 113° F				
Thermal dissipation	Fan, continuously variable speed, temperature controlled				
Idle	382 BTU/h 96 kcal/h				
1/8 of max out power @4Ω	836 BTU/h 211 kcal/h				
1/4 of max out power @4Ω	1,390 BTU/h 326 kcal/h				
Audio					
Gain, selectable	26 dB	29 dB	32 dB	35 dB	
Input Sensitivity @ 8 Ω	5.30 V	3.75 V	2.66 V	1.88 V	
Max input level	27 dBu	24 dBu	21 dBu	18 dBu	
Gate	-52 dBu	-55 dBu	-58 dBu	-61 dBu	
Frequency response	20 Hz - 20 kHz (1 W @ 8 Ω, ±0.5 dB)				
S/N ratio (amplifier section)	>106 dBA (20 Hz - 20 kHz, A weighted)				
Crosstalk separation	> 70 dB @ 1 kHz				
Input Impedance	10 k Ω balanced				
THD+N/SMPTE & DIM 100 IMD	<0.3% from 1 W to full power (typically <0.05%)				
Slew rate	50 V/μs @ 8 Ω, input filter bypassed				
Damping factor @ 8Ω	>5000 @ 20-200 Hz				
Front Panel					
Indicators	7 meter LEDs				
Controls	4 pushbuttons + mains switch				
Maintenance	SmartCard reader/writer.				
Rear Panel					
Audio input connectors	Analog: 2×balanced Neutrik® xLR female; AES3: use channel 2 xLR				
Audio output connectors	Analog: 2×balanced Neutrik® xLR male				
Speaker output connectors	2×Neutrik® Speakon NL4MD				
Network data port	RS485 1×RJ45 with 2 recessed rotary encoders for ID selection				
Aux voltage	1×2-pin Phoenix P. 3.81mm				
AC mains	IEC20A with IEC20A Schuko for EU, IEC20A/American 15 A pin plug				
Controls	1×link switch, linking analog inputs 1 and 2; AES3/analog input switch				
Construction					
Dimensions	W 483 mm / 19", H 44.5 mm / 1 RU, D 380 mm / 15"				
Weight	8 kg (17.7 lb)				







# ***APG***

---

APG France

332 bd Marcel Paul, CP602 - 44800 Saint-Herblain Cedex

RCS Pontoise 451935084

Tel. : +33 (0)1 48 63 84 25 - E-mail : [contact@apg.audio](mailto:contact@apg.audio)

Site : [www.apg.audio](http://www.apg.audio)