

# APG

## QUICK START - UC118i

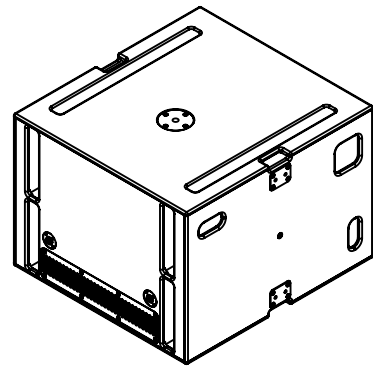

FR

Les enceintes APG UC118i sont destinées à des utilisations fixes ou mobiles.

Raccorder l'enceinte à l'amplificateur au moyen d'un câble de section minimale 2,5mm<sup>2</sup> raccordé sur le connecteur Speakon.

EN

APG UC118i loudspeakers have been designed for fixed or mobile use.

Connect the loudspeaker to the amplifier using a cable with a minimum cross section of 2.5mm<sup>2</sup> connected to the Speakon connector.

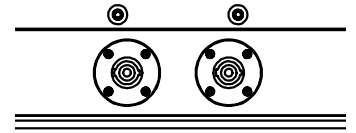
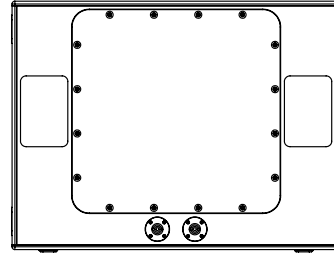
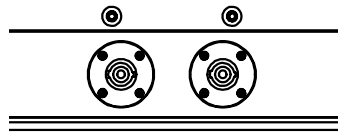
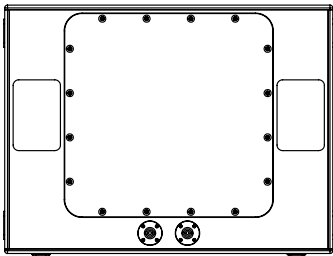

L'enceinte peut être utilisée au sol ou suspendue grâce aux accessoires optionnels adaptés.

Position the loudspeakers on a flat support where it can be fixed on a fixed or mobile support using the appropriate optional accessories.

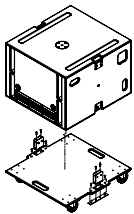

UC118iBW

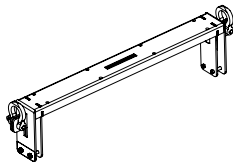

EBK

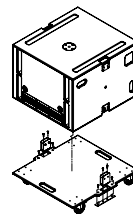
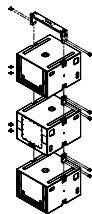

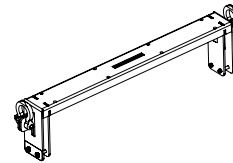

UC118iBW

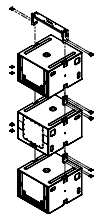

EBK



 Veiller à assurer la stabilité de l'ensemble et à protéger le public des sur niveaux sonores.

 Take care to ensure the stability and to protect the public from excessive sound levels.

Avant toute utilisation lire le manuel disponible en scannant le code ci-dessous :

Before use, read the manual available by scanning the code below :

